

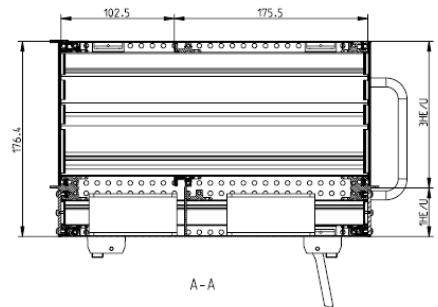

**4U/ 42 HP Chassis
VPX**

VPX

5 Slot Backplane, 300 W



Key features:

- 4U (1+3) 42 HP VPX Desktop Chassis Platform
- Card rack acc. to IEEE 1101.1, 1101.10/11 and IEC 60297-3-101, -102, -103
- VPX Backplane, 3U, 5 Slot, Full Mesh configuration X4 on P1, with rear I/O,
- ATX power supply unit 300 W with, wide range input 90 – 264 VAC, 47 - 63 Hz (3.3 V / 17 A, 5 V / 18 A, 12 V / 24 A, -12 V / 0.3 A) with PFC, efficiency: typ. 87% at 115V, full load, with fan and switch, with cable harness for connection, to backplane, incl. 3U / 10HP front panel
- Cooled by 2x +12V DC fans 80mm, air flow from bottom to top
- Completely assembled and wired
- Other configurations on request

Dimensions
B: 235.7 mm
H: 176.4 mm
D: 278.0 mm

Order number: LMH0000940

